

**Drawing(mm)**

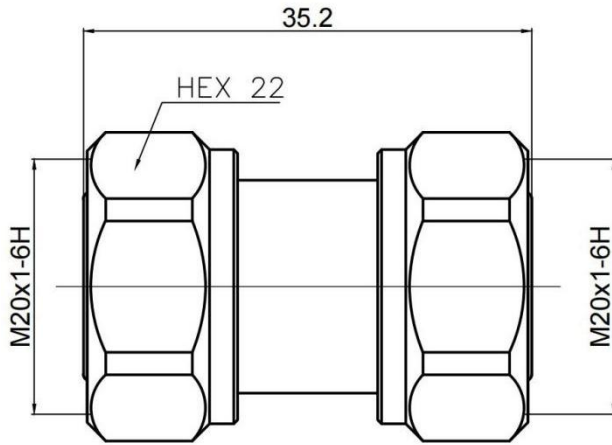

**Electrical & Environmental**

<b>Impedance</b>	50 ohm
<b>Frequency Range</b>	DC-6 GHz
<b>VSWR</b>	1.25 max
<b>PIM (Intermod)</b>	-160dBc min with 2×20W tones
<b>Operating Temp</b>	-40°C ~ +125°C
<b>RoHS</b>	Compliant

**Material**

<b>Connector Body</b>	Ternary alloy plated brass
<b>Center Contact</b>	Silver plated brass
<b>Insulator</b>	PTFE
<b>Weight</b>	86g