

Drawing(mm)

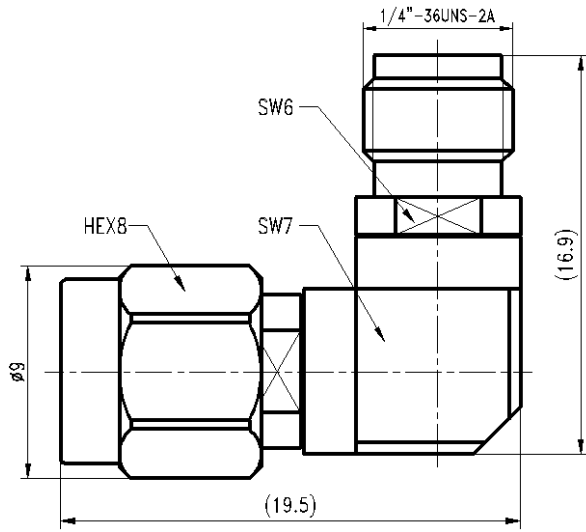

Electrical & Environmental

Impedance	50 ohm
Frequency Range	DC-27 GHz
VSWR	1.25 max
Operating Temp	-55°C to +165°C
Interface	3.5mm per IEC 60169

Material

Connector Body	Passivated stainless steel
Center Contact	Gold plated beryllium copper
Insulator	PEI

Typical Test Data

