

Drawing(mm)

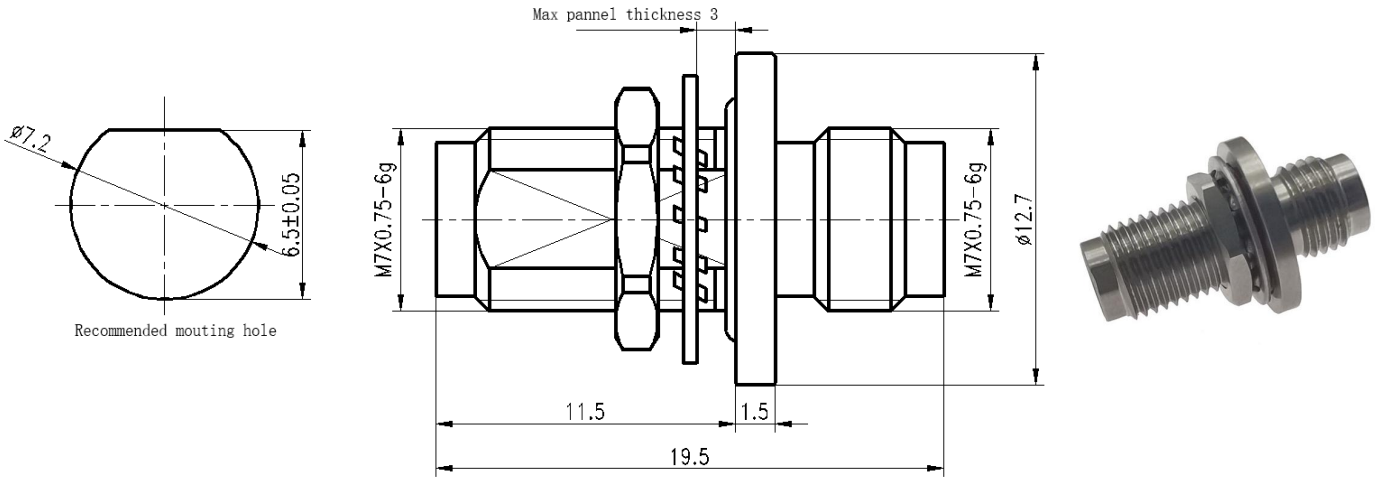

Electrical & Environmental

| | |
|-----------------|---------------------|
| Impedance | 50 ohm |
| Frequency Range | 50 GHz |
| VSWR | 1.2 max |
| Operating Temp | -55°C to +165°C |
| Interface | 2.4mm per IEC 61169 |

Material

| | |
|----------------|------------------------------|
| Connector Body | Passivated stainless steel |
| Center Contact | Gold plated beryllium copper |
| Insulator | PEI |

Typical Test Data

