

Drawing(mm)

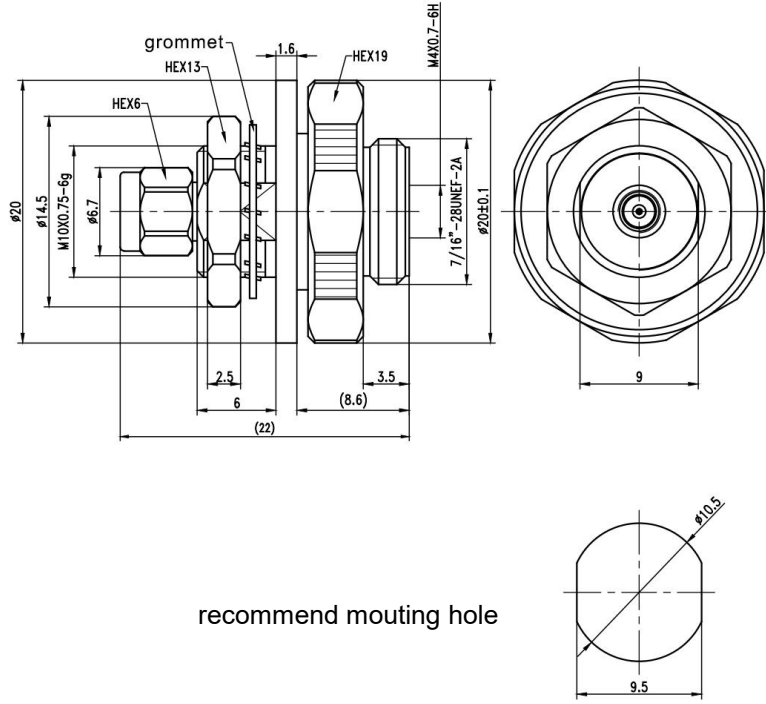

Electrical & Environmental

Impedance	50 ohm
Frequency Range	DC-110 GHz
VSWR	1.4 max
Operating Temperature	-55°C to +165°C

Mechanical

Connector Body	Passivated stainless steel
Center Contact	Gold plated beryllium copper
Insulator	PEI
Mating Life	500 times min