

Drawing(mm)

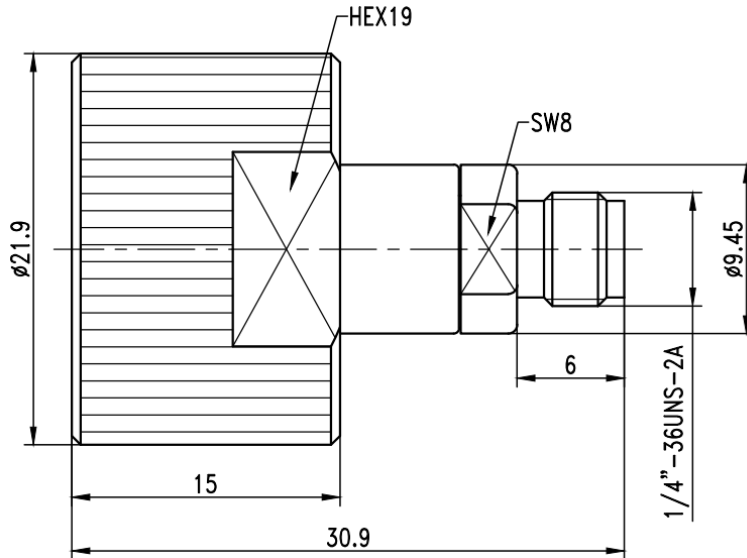

Electrical & Environmental

Impedance	50 ohm
Frequency Range	DC-40 GHz
VSWR	1.15 max
Operating Temperature	-55°C to +165°C

Mechanical

Connector Body	Passivated stainless steel
Center Contact	Gold plated beryllium copper
Insulator	PEI
Mating Life	2000 times min