



DC -6.5 GHz Low Pass Filter

LPF-6D5GS1

RVA 1

Specifications

1	Pass Band Frequency	DC ~ 6.5 GHz
2	Pass Band Insertion Loss	≤1.0dB @ DC ~ 6.4GHz ≤1.5dB @6.4 ~ 6.5GHz
3	Pass Band VSWR	≤1.3
4	Stop Band Rejection	≥60dB @ 7.27 ~ 15.3GHz
5	Impedance	50 Ohms
6	Power Handling	15W Max.
7	Connectors	SMA Female
8	Surface Finish	Black Painted
9	Temperature Range	-55°C ~ +85°C
10	Dimensions	31*23*10mm
11	Net weight	About 23g

Dimensions (Unit: mm, Tolerance: ±0.3mm)

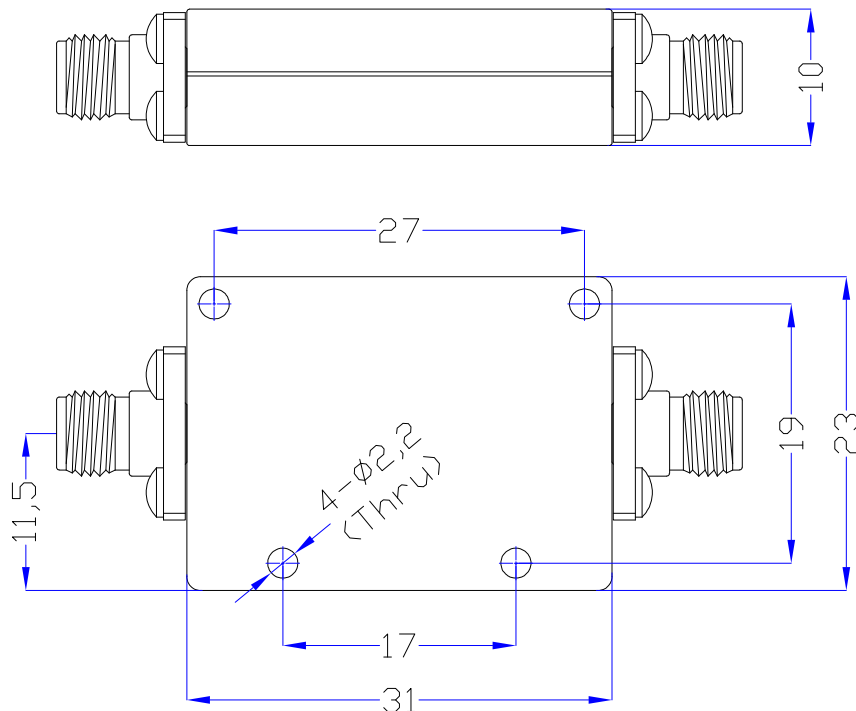



DC -6.5 GHz Low Pass Filter

LPF-6D5GS1

RVA 1

Typical Test Data

