



### Electrical

<b>Impedance</b>	50 ohm				
<b>Frequency Range</b>	DC-4 GHz				
<b>VSWR</b>	1.2 max				
<b>Input Avg Power</b>	100W@ 25°C ambient, derating linearly to 10W at 100°C				
<b>Peak Power</b>	5kW (5 micro-sec pulse width, 0.5% duty cycle)				
<b>Direction</b>	Unidirectional, N male input, N female output (other configurations available)				

<b>Attenuation(dB)</b>	6-10	20	30	40	50,60
<b>Accuracy(dB)</b>	±0.7	±0.7	±0.8	±0.8	±0.9

### Mechanical

<b>Connector Body</b>	Ternary alloy plated brass
<b>Heat Sink</b>	Black anodized aluminum
<b>Center Contact</b>	Gold plated beryllium copper/brass
<b>Net Weight</b>	About 350g

### Environmental

<b>Operating Temperature</b>	-55°C to 100°C
<b>Storage Temperature</b>	-55°C to 125°C
<b>RoHS</b>	Compliant
<b>Temperature Coefficient</b>	<0.0004 dB/dB/°C

### Dimensions(mm)

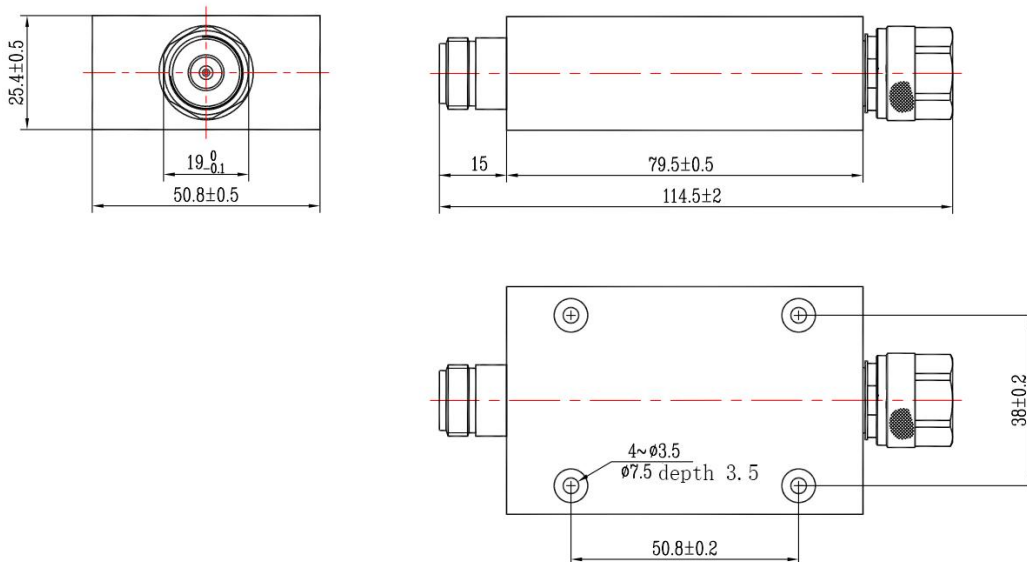

### Notes

1. Always pay attention to the direction of attenuators.
2. To maintain best performance, recommended to use fan to keep the case temperature under 85°C.
3. Customized dB values, outlines and optimal accuracy/VSWR available.

### Model Description

#### RFH04XXND100-DC

1. XX for dB value: 06=6dB, 30=30dB
2. Code for connector configuration:  
 A=female for two ends; B=male for two ends  
 C=female for input and male for output;  
 D=male for input and female for output.