



Electrical

Impedance	50 ohm			
Frequency Range	DC-6 GHz			
VSWR	1.25 max			
Input Avg Power	50W@ 25°C ambient, derating linearly to 5W at 100°C			
Peak Power	1kW (5 micro-sec pulse width, 2% duty cycle)			
Direction	Unidirectional, TNC male input, TNC female output (other configurations available)			

Attenuation(dB)	1-10	20	30	40-50
Accuracy(dB)	±0.5	±0.6	±0.8	±0.8

Mechanical

Connector Body	Ternary alloy plated brass
Heat Sink	Black anodized aluminum
Center Contact	Gold plated beryllium copper/brass
Net Weight	About 1000 g

Environmental

Operating Temperature	-55°C to 100°C
Storage Temperature	-55°C to 125°C
RoHS	Compliant
Temperature Coefficient	<0.0004 dB/dB/°C

Dimensions(mm)

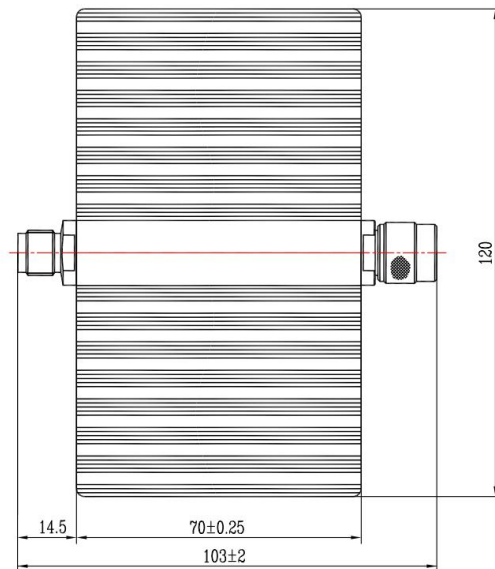
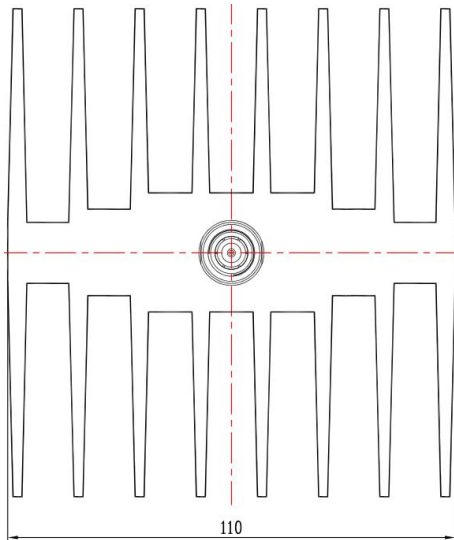

Notes

1. Always pay attention to the direction of attenuators.
2. To maintain best performance, recommended to use fan to keep the case temperature under 85°C.
3. Customized dB values, outlines and optimal accuracy/VSWR available.

Model Description

RFH06XXTD50-D

1. XX for dB value: 06=6dB, 30=30dB
2. Code for connector configuration:
 A=female for two ends; B=male for two ends
 C=female for input and male for output;
 D=male for input and female for output.