



## Coaxial RF Termination

**RFT1250T1**

**DC-12.4 GHz, TNC Female, 50 Watts**

Rev 3

### Electrical

<b>Impedance</b>	50 ohm
<b>Frequency Range</b>	DC-12.4 GHz
<b>VSWR</b>	1.3 max
<b>Input Avg Power</b>	50W@ 25°C ambient, derating linearly to 5W at 100°C
<b>Peak Power</b>	1kW (5 micro-sec pulse width, 2% duty cycle)

### Mechanical

<b>Connector Body</b>	Ternary alloy plated brass
<b>Center Contact</b>	Gold plated beryllium copper
<b>Heat Sink</b>	Black anodized aluminum

### Environmental

<b>Operating Temp</b>	-55°C to 100°C
<b>Storage Temp</b>	-55°C to 125°C
<b>RoHS</b>	Compliant

### Dimensions(mm)

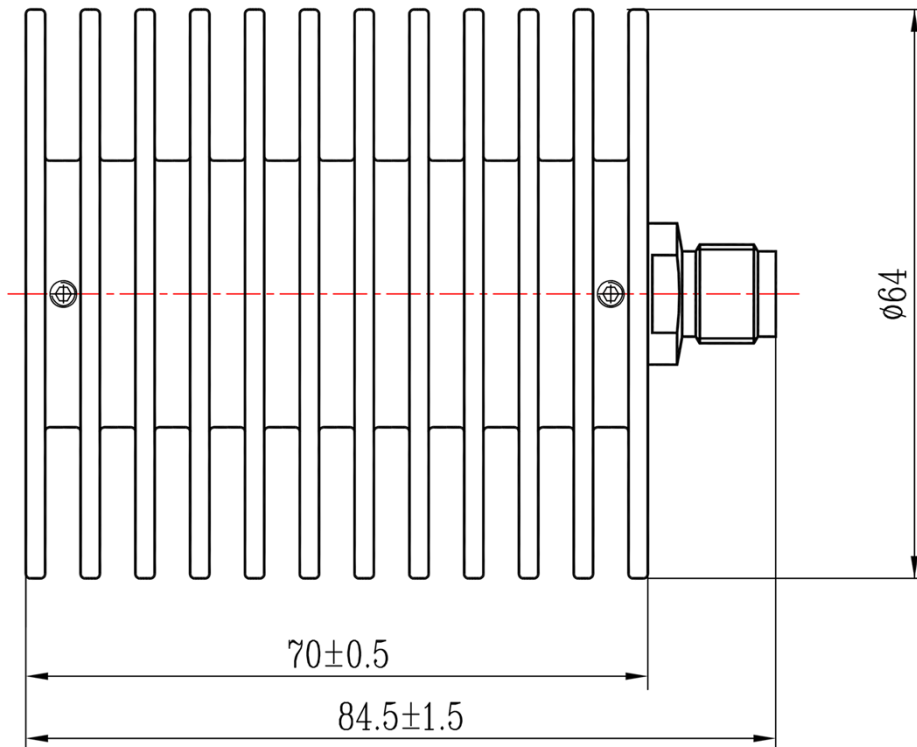

### Notes

1. Customized outlines and optimal VSWR available.
2. To maintain best performance, recommended to use fan to keep the case temperature under 85°C.