



Electrical

Impedance	50 ohm
Frequency Range	DC-18 GHz
VSWR	1.3 max
Input Avg Power	2W@ 25°C ambient, derating linearly to 0.2W at 100°C
Peak Power	250W (5 micro-sec pulse width, 0.4% duty cycle)

Mechanical

Connector Body	Passivated stainless steel
Center Contact	Gold plated beryllium copper
Heat Sink	N/A

Environmental

Operating Temp	-55°C to 100°C
Storage Temp	-55°C to 125°C
RoHS	Compliant

Dimensions(mm)

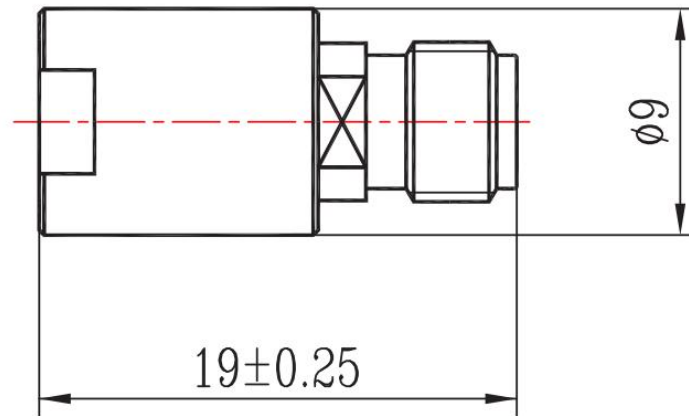

Notes

1. Customized outlines and optimal VSWR available.