

10 dBi Gain, 26.3-40 GHz, WR28 Standard Gain Horn with UBR320

Flange

Rev 1

Electrical

Frequency Range	26.3-40 GHz
Norminal Gain	10 dBi
Polarization	Linear
VSWR	1.25 max
3dB Beamwidth	E-Plane: 32.5~50.6 deg, H-Plane: 37.8~54.9 deg
Operating Temperature	-40°C~+70°C

Mechanical

Waveguide Size	WR28
Flange Type	UBR320 Square Cover Flange
Body Material and Finish	Copper, Painted

Dimensions(mm)

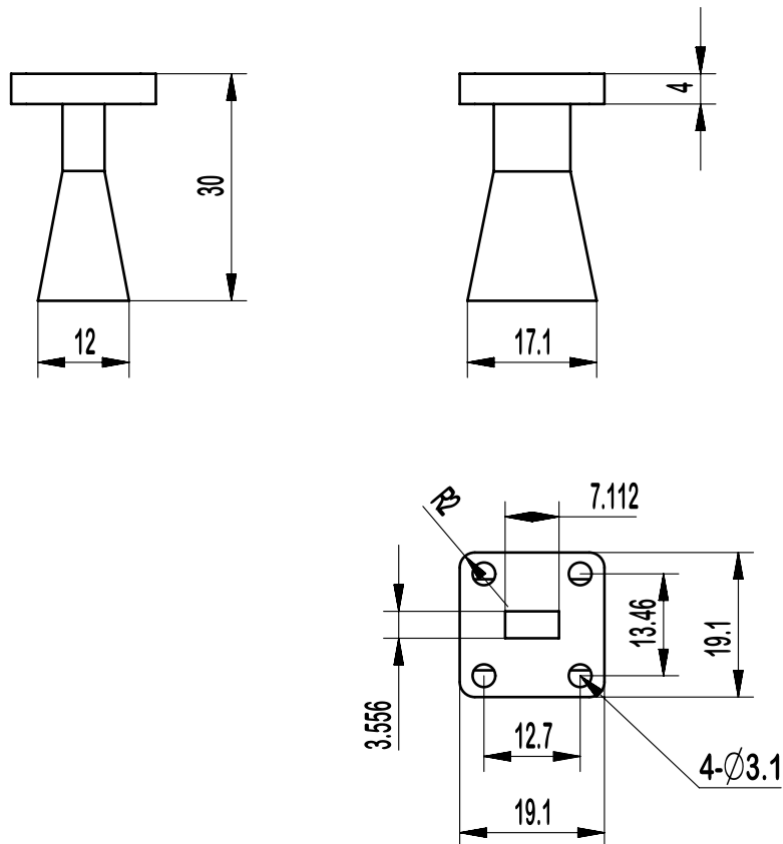

Typical VSWR

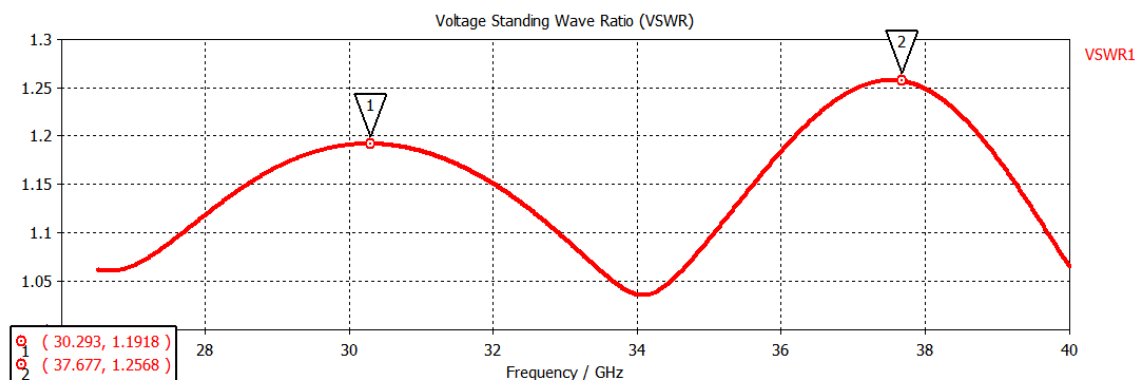

Gain

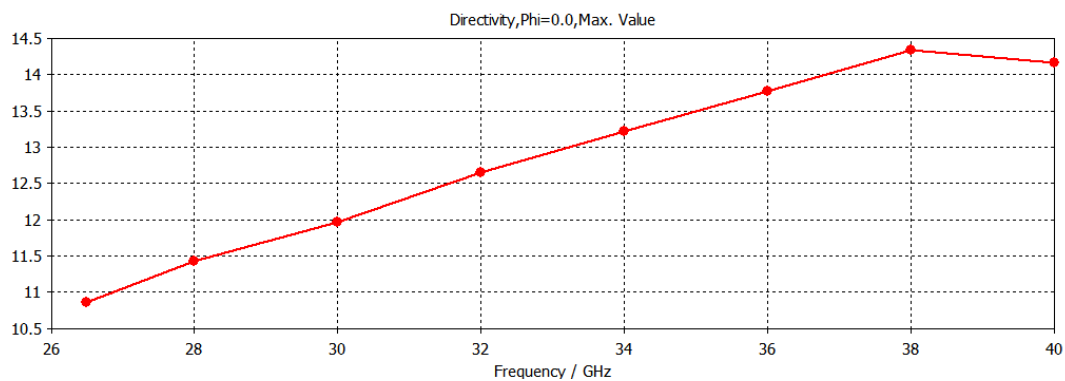

Simulated Antenna Patterns

26.5GHz E-Plane

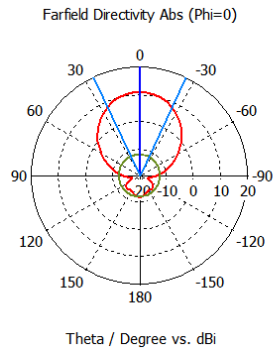

farfield (f=26.5) [1]

Frequency = 26.5
 Main lobe magnitude = 10.9 dBi
 Main lobe direction = 0.0 deg.
 Angular width (3 dB) = 50.6 deg.
 Side lobe level = -23.0 dB

H-Plane

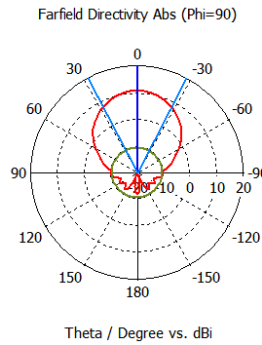

farfield (f=26.5) [1]

Frequency = 26.5
 Main lobe magnitude = 10.9 dBi
 Main lobe direction = 0.0 deg.
 Angular width (3 dB) = 54.6 deg.
 Side lobe level = -21.2 dB

28GHz E-Plane

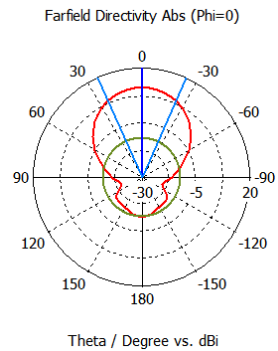

farfield (f=28) [1]

Frequency = 28
 Main lobe magnitude = 11.4 dBi
 Main lobe direction = 0.0 deg.
 Angular width (3 dB) = 47.9 deg.
 Side lobe level = -23.3 dB

H-Plane

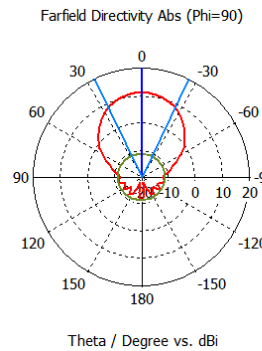

farfield (f=28) [1]

Frequency = 28
 Main lobe magnitude = 11.4 dBi
 Main lobe direction = 0.0 deg.
 Angular width (3 dB) = 51.2 deg.
 Side lobe level = -22.6 dB

30GHz E-Plane

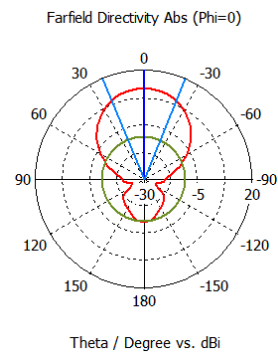

farfield (f=30) [1]

Frequency = 30
 Main lobe magnitude = 12.0 dBi
 Main lobe direction = 0.0 deg.
 Angular width (3 dB) = 45.1 deg.
 Side lobe level = -22.4 dB

H-Plane

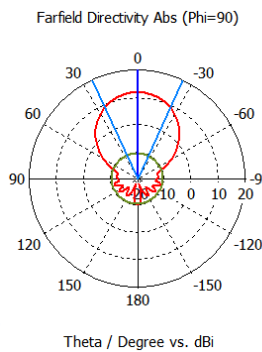

farfield (f=30) [1]

Frequency = 30
 Main lobe magnitude = 12.0 dBi
 Main lobe direction = 0.0 deg.
 Angular width (3 dB) = 49.4 deg.
 Side lobe level = -22.4 dB

32GHz E-Plane

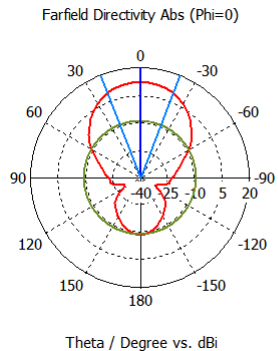

farfield (f=32) [1]

Frequency = 32
 Main lobe magnitude = 12.6 dBi
 Main lobe direction = 0.0 deg.
 Angular width (3 dB) = 41.9 deg.
 Side lobe level = -21.6 dB

H-Plane

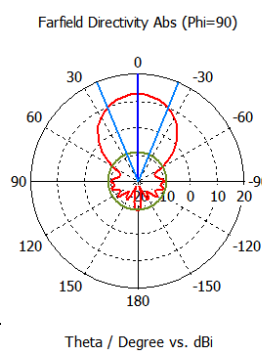

farfield (f=32) [1]

Frequency = 32
 Main lobe magnitude = 12.6 dBi
 Main lobe direction = 0.0 deg.
 Angular width (3 dB) = 44.7 deg.
 Side lobe level = -21.6 dB

34GHz E-Plane

Farfield Directivity Abs (Phi=0)

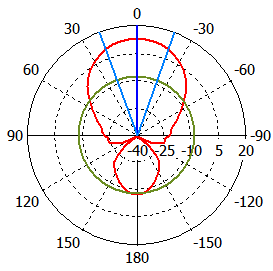

Theta / Degree vs. dBi

farfield (f=34) [1]

Frequency = 34
Main lobe magnitude = 13.2 dBi
Main lobe direction = 0.0 deg.
Angular width (3 dB) = 40.0 deg.
Side lobe level = -21.1 dB

H-Plane

Farfield Directivity Abs (Phi=90)

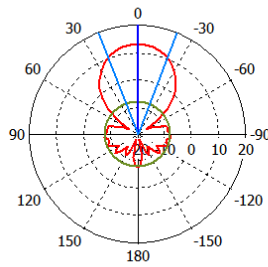

Theta / Degree vs. dBi

farfield (f=34) [1]

Frequency = 34
Main lobe magnitude = 13.2 dBi
Main lobe direction = 0.0 deg.
Angular width (3 dB) = 42.1 deg.
Side lobe level = -21.1 dB

36GHz E-Plane

Farfield Directivity Abs (Phi=0)

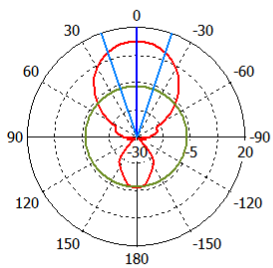

Theta / Degree vs. dBi

farfield (f=36) [1]

Frequency = 36
Main lobe magnitude = 13.8 dBi
Main lobe direction = 0.0 deg.
Angular width (3 dB) = 37.9 deg.
Side lobe level = -20.3 dB

H-Plane

Farfield Directivity Abs (Phi=90)

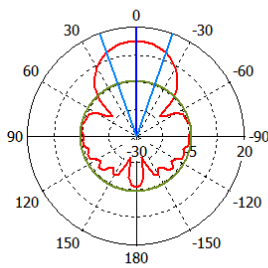

Theta / Degree vs. dBi

farfield (f=36) [1]

Frequency = 36
Main lobe magnitude = 13.8 dBi
Main lobe direction = 0.0 deg.
Angular width (3 dB) = 38.9 deg.
Side lobe level = -18.2 dB

38GHz E-Plane

Farfield Directivity Abs (Phi=0)

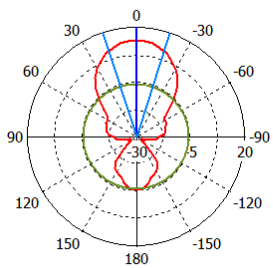

Theta / Degree vs. dBi

farfield (f=38) [1]

Frequency = 38
Main lobe magnitude = 14.3 dBi
Main lobe direction = 0.0 deg.
Angular width (3 dB) = 35.4 deg.
Side lobe level = -19.9 dB

H-Plane

Farfield Directivity Abs (Phi=90)

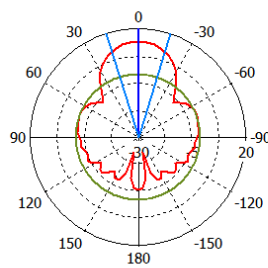

Theta / Degree vs. dBi

farfield (f=38) [1]

Frequency = 38
Main lobe magnitude = 14.3 dBi
Main lobe direction = 0.0 deg.
Angular width (3 dB) = 34.7 deg.
Side lobe level = -15.2 dB

40GHz E-Plane

Farfield Directivity Abs (Phi=0)

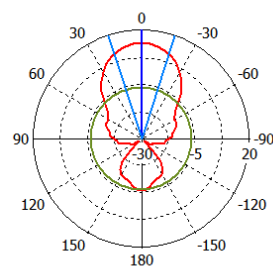

Theta / Degree vs. dBi

farfield (f=40) [1]

Frequency = 40
Main lobe magnitude = 14.2 dBi
Main lobe direction = 0.0 deg.
Angular width (3 dB) = 35.3 deg.
Side lobe level = -20.6 dB

H-Plane

Farfield Directivity Abs (Phi=90)

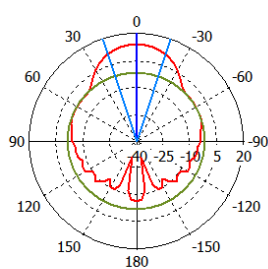

Theta / Degree vs. dBi

farfield (f=40) [1]

Frequency = 40
Main lobe magnitude = 14.2 dBi
Main lobe direction = 0.0 deg.
Angular width (3 dB) = 36.5 deg.
Side lobe level = -15.6 dB