

15 dBi Gain, 2.6-3.95 GHz, WR284 Standard Gain Horn with UDR32

Flange

Rev 1

Electrical

Frequency Range	2.6-3.95 GHz
Norminal Gain	15 dBi
Polarization	Linear
VSWR	1.2 max
3dB Beamwidth	E-Plane: 23.4~32.0 deg, H-Plane: 23.1~34.4 deg
Operating Temperature	-40°C~+70°C

Mechanical

Waveguide Size	WR284
Flange Type	UDR32 Rectangular Cover Flange
Body Material and Finish	Aluminum, Painted
Weight	785g

Dimensions(mm)

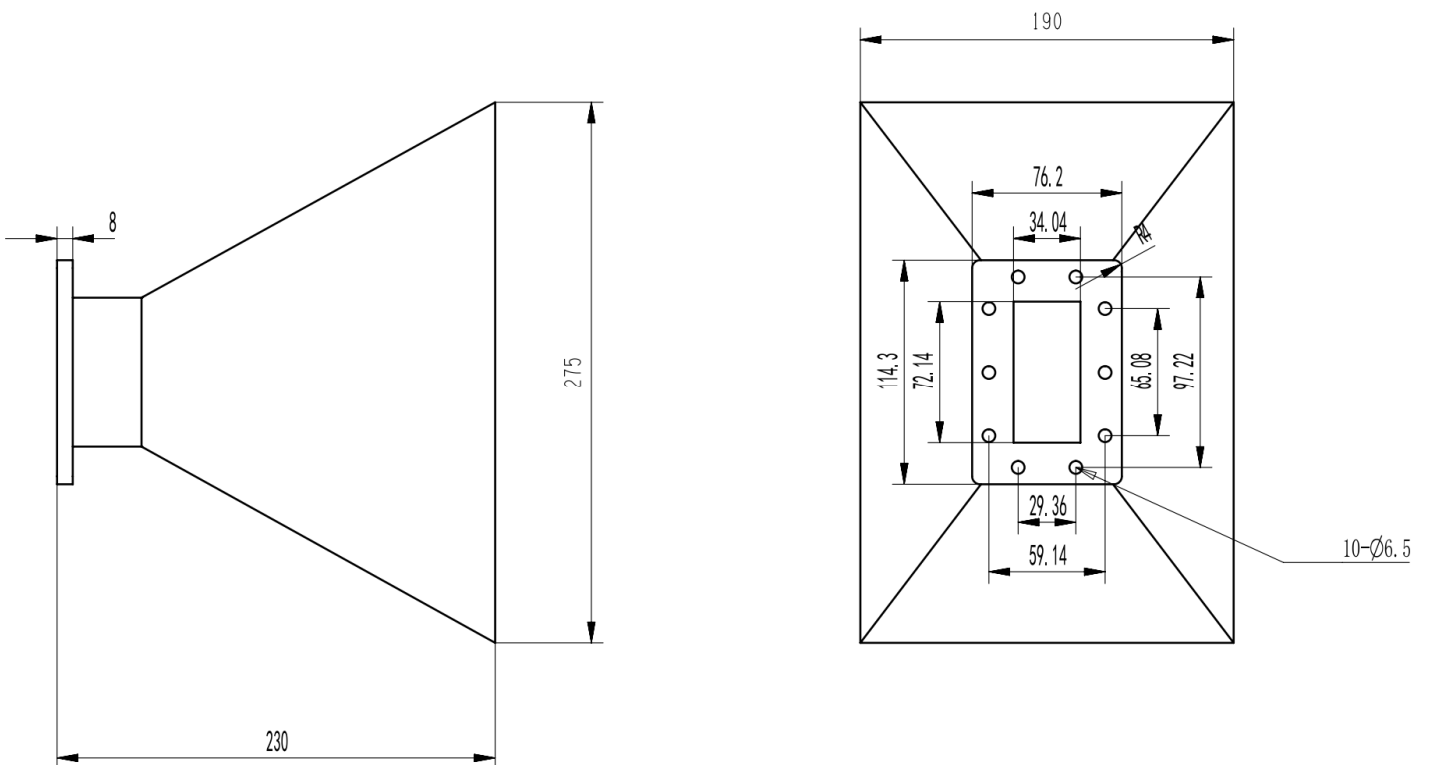

Typical VSWR

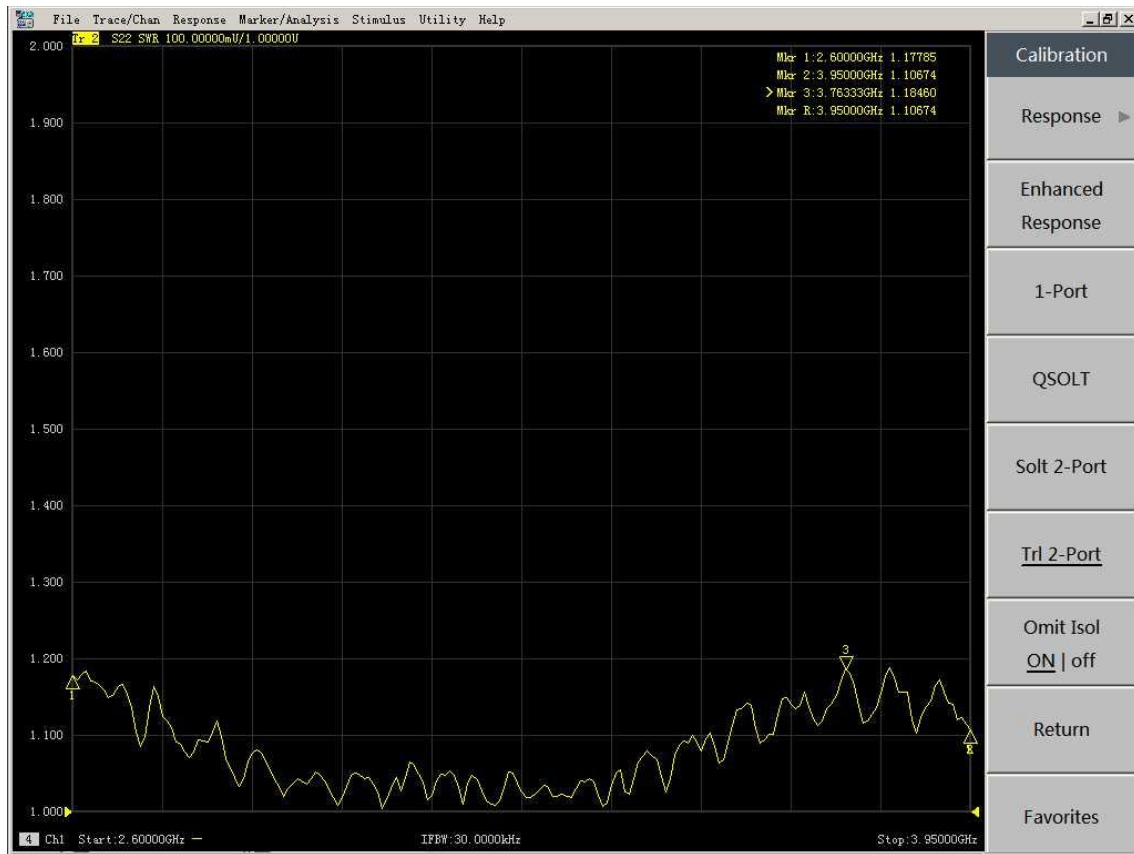

Gain

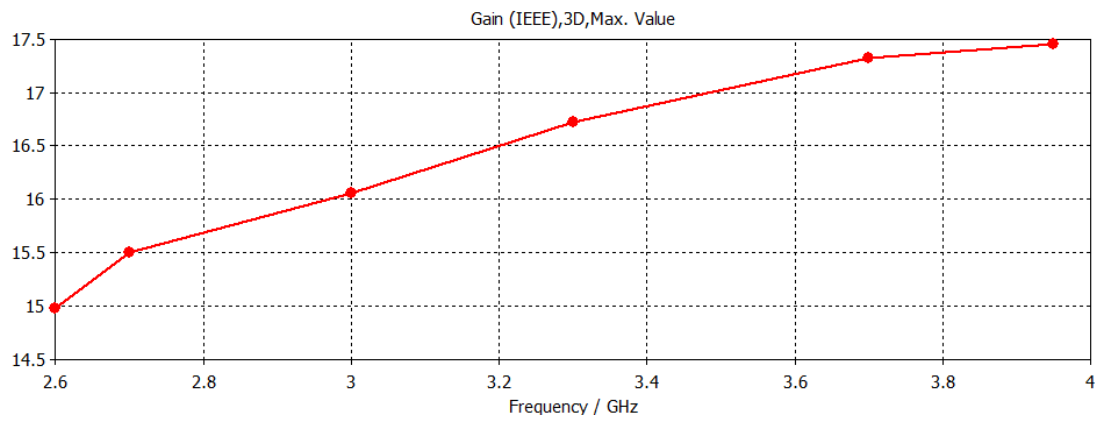

Simulated Antenna Patterns

2.6GHz E-Plane

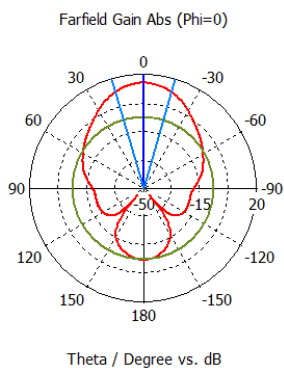

farfield (f=2.6) [1]

Frequency = 2.6
Main lobe magnitude = 15.0 dB
Main lobe direction = 0.0 deg.
Angular width (3 dB) = 32.0 deg.
Side lobe level = -21.0 dB

2.6GHz H-Plane

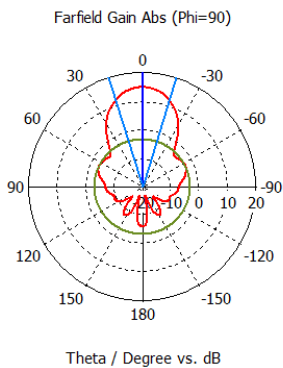

farfield (f=2.6) [1]

Frequency = 2.6
Main lobe magnitude = 15.0 dB
Main lobe direction = 0.0 deg.
Angular width (3 dB) = 34.4 deg.
Side lobe level = -18.2 dB

2.7GHz E-Plane

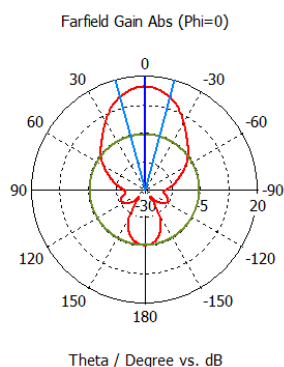

farfield (f=2.7) [1]

Frequency = 2.7
Main lobe magnitude = 15.5 dB
Main lobe direction = 0.0 deg.
Angular width (3 dB) = 30.2 deg.
Side lobe level = -21.0 dB

2.7GHz H-Plane

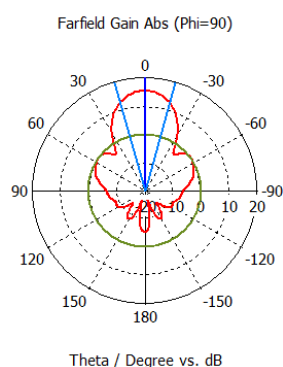

farfield (f=2.7) [1]

Frequency = 2.7
Main lobe magnitude = 15.5 dB
Main lobe direction = 0.0 deg.
Angular width (3 dB) = 31.4 deg.
Side lobe level = -15.3 dB

3.0GHz E-Plane

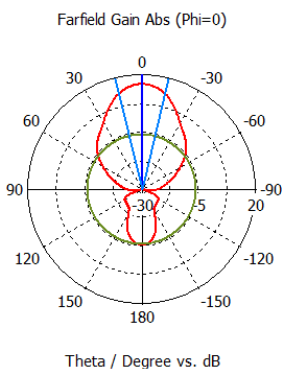

farfield (f=3) [1]

Frequency = 3
Main lobe magnitude = 16.1 dB
Main lobe direction = 0.0 deg.
Angular width (3 dB) = 26.9 deg.
Side lobe level = -21.9 dB

3.0GHz H-Plane

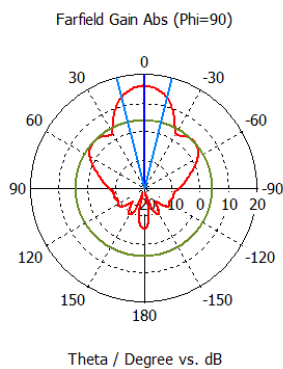

farfield (f=3) [1]

Frequency = 3
Main lobe magnitude = 16.1 dB
Main lobe direction = 0.0 deg.
Angular width (3 dB) = 27.5 deg.
Side lobe level = -11.8 dB

3.3GHz E-Plane

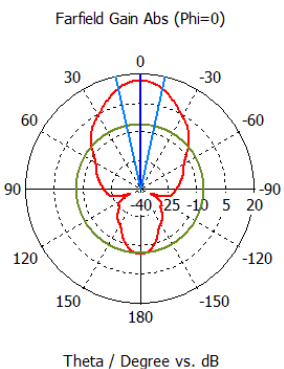

farfield (f=3.3) [1]

Frequency = 3.3
Main lobe magnitude = 16.7 dB
Main lobe direction = 0.0 deg.
Angular width (3 dB) = 25.3 deg.
Side lobe level = -22.8 dB

3.3GHz H-Plane

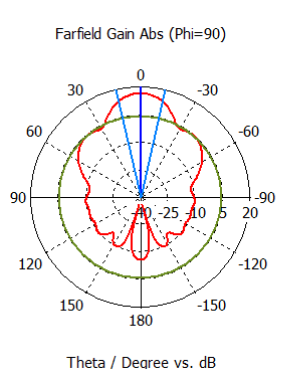

farfield (f=3.3) [1]

Frequency = 3.3
Main lobe magnitude = 16.7 dB
Main lobe direction = 0.0 deg.
Angular width (3 dB) = 25.8 deg.
Side lobe level = -12.2 dB

3.7GHz E-Plane

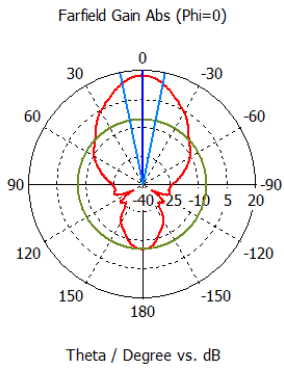

farfield (f=3.7) [1]

Frequency = 3.7
 Main lobe magnitude = 17.3 dB
 Main lobe direction = 0.0 deg.
 Angular width (3 dB) = 23.0 deg.
 Side lobe level = -23.1 dB

H-Plane

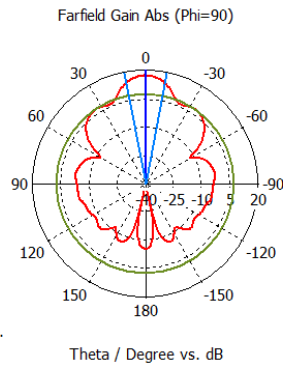

farfield (f=3.7) [1]

Frequency = 3.7
 Main lobe magnitude = 17.3 dB
 Main lobe direction = 0.0 deg.
 Angular width (3 dB) = 22.0 deg.
 Side lobe level = -9.9 dB

3.95GHz E-Plane

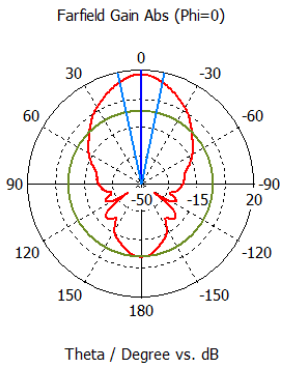

farfield (f=3.95) [1]

Frequency = 3.95
 Main lobe magnitude = 17.5 dB
 Main lobe direction = 0.0 deg.
 Angular width (3 dB) = 23.4 deg.
 Side lobe level = -22.4 dB

H-Plane

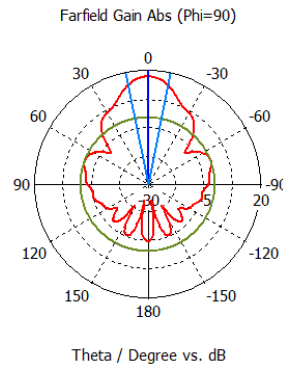

farfield (f=3.95) [1]

Frequency = 3.95
 Main lobe magnitude = 17.5 dB
 Main lobe direction = 0.0 deg.
 Angular width (3 dB) = 23.1 deg.
 Side lobe level = -17.7 dB